



**PHOTIUS**  
INTEGRATED CCT

## PHOEBE LED PHOTIUS INTEGRATED CCT

Features CCT Technology and Slim Design



Standard, Microwave Sensor and Emergency Models Available

- Features CCT technology
- 3000K/4000K/6000K tri-colour select
- 4ft/5ft length options
- Suspension kit included



## 40W and 60W Photius Integrated CCT

The Photius Integrated LED CCT batten features CCT technology allowing the colour temperature to be quickly changed between 3000K, 4000K and 6000K with its easy access switch.

It is available in 4ft and 5ft lengths with a choice of standard, microwave sensor and 3-hour emergency models.

With a slim-line, stylish design and flicker-free light output, the Photius is ideally suited for a variety of indoor commercial applications.

- 35,000 hour life (20,000 for emergency version)
- 100,000 switching cycles
- 120° beam angle
- 3000K/4000K/6000K tri-colour select
- High efficiency 120lm/W
- Colour rendering index  $\geq 80$
- IP42 rated
- For indoor use only
- Not suitable for dimming
- 5 year warranty



## Adaptable, Stylish and Reliable

Developed and designed to be the ideal solution for settings such as offices, residential, commercial and other lighting applications where dependability and quality light are required.



Crompton Lamps Limited  
Unit 2  
Marrtree Business Park  
Bawling Back Lane  
Bradford  
BD4 8QE

Tel: 01274 657 088  
Fax: 01274 657 087

Email: [sales@cromptonlamps.com](mailto:sales@cromptonlamps.com)  
[www.cromptonlamps.com](http://www.cromptonlamps.com)

**Trade Descriptions:** All descriptions represent only particulars of the goods to which they apply and do not form part of any contract. Due to policy of continuous development and improvement, Crompton Lamps Limited reserves the right to change the specification and performance data of the products listed without prior notice or public announcement.

# 3-Hour Emergency Model

- Discharge  $\geq$  3 Hours
- 24 hour Charge Time
- Built-in Emergency Test Function

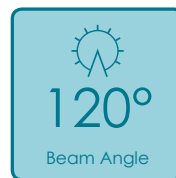

# Microwave Sensor Model

- 6m Max Detection Range
- 5secs - 10min Hold Time
- 120° Detection Angle
- Light output turns off or dims to 20% when sensor not triggered
- Easy access module for quick adjustment to sensor settings

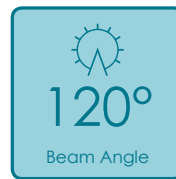
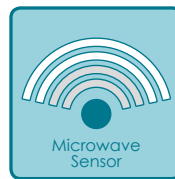

# Quick and Easy Installation

The Photius features a 3-way terminal block to ensure installation is quick and simple. (Emergency model has a 4-way terminal block with continuous live feed).

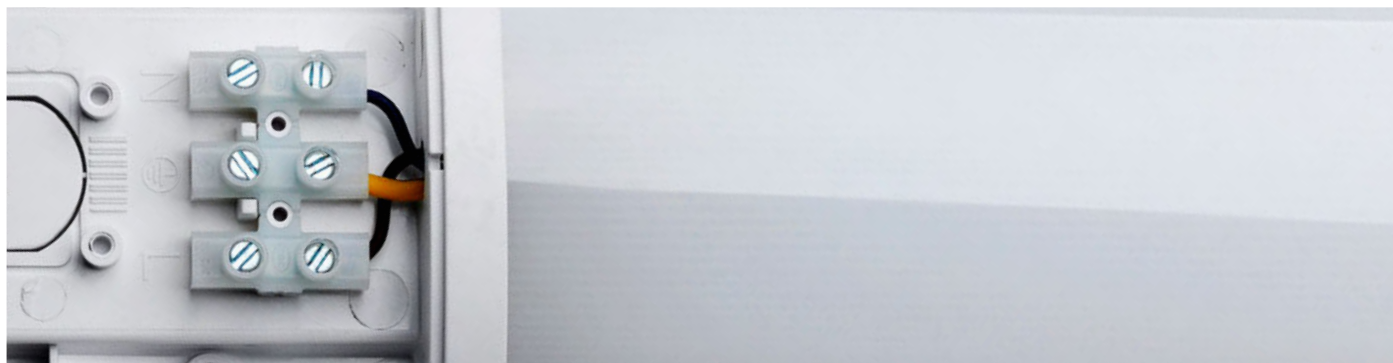

Crompton Lamps Limited  
Unit 2  
Marrtree Business Park  
Bowling Back Lane  
Bradford  
BD4 8QE

Tel: 01274 657 088  
Fax: 01274 657 087

Email: [sales@cromptonlamps.com](mailto:sales@cromptonlamps.com)  
[www.cromptonlamps.com](http://www.cromptonlamps.com)

**Trade Descriptions:** All descriptions represent only particulars of the goods to which they apply and do not form part of any contract. Due to policy of continuous development and improvement, Crompton Lamps Limited reserves the right to change the specification and performance data of the products listed without prior notice or public announcement.



# Tri-Colour Selection

A key function of the Photius is the option to switch the colour temperature between 3000K, 4000K and 6000K.

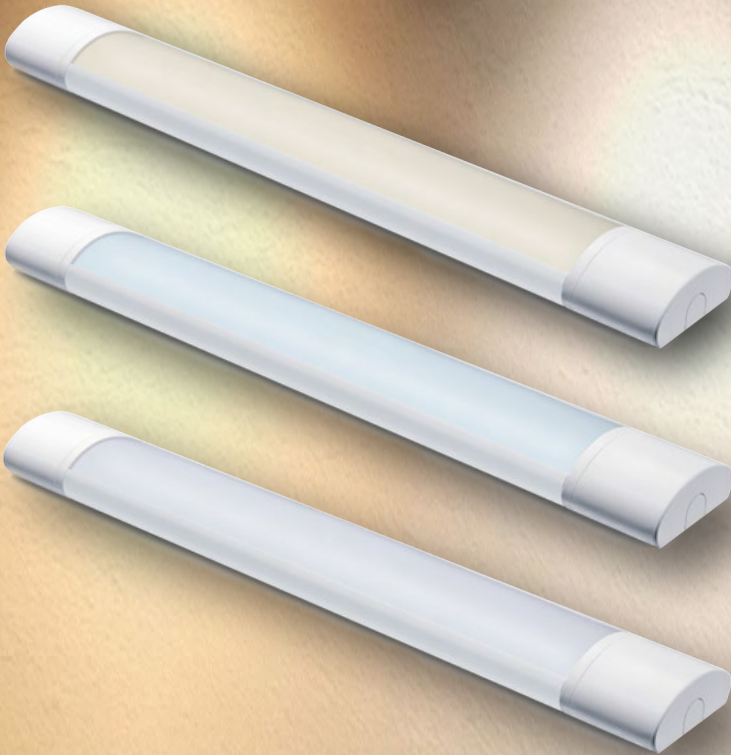

3000K  
WARM WHITE

4000K  
COOL WHITE

6000K  
DAYLIGHT



## Easy Access Switch

Changing the colour temperature is quick and simple thanks to the easy access switch.



Crompton Lamps Limited  
Unit 2  
Marrtree Business Park  
Bowling Back Lane  
Bradford  
BD4 8QE

Tel: 01274 657 088  
Fax: 01274 657 087

Email: [sales@cromptonlamps.com](mailto:sales@cromptonlamps.com)  
[www.cromptonlamps.com](http://www.cromptonlamps.com)

**Trade Descriptions:** All descriptions represent only particulars of the goods to which they apply and do not form part of any contract. Due to policy of continuous development and improvement, Crompton Lamps Limited reserves the right to change the specification and performance data of the products listed without prior notice or public announcement.

# Eliminates Visible Flicker

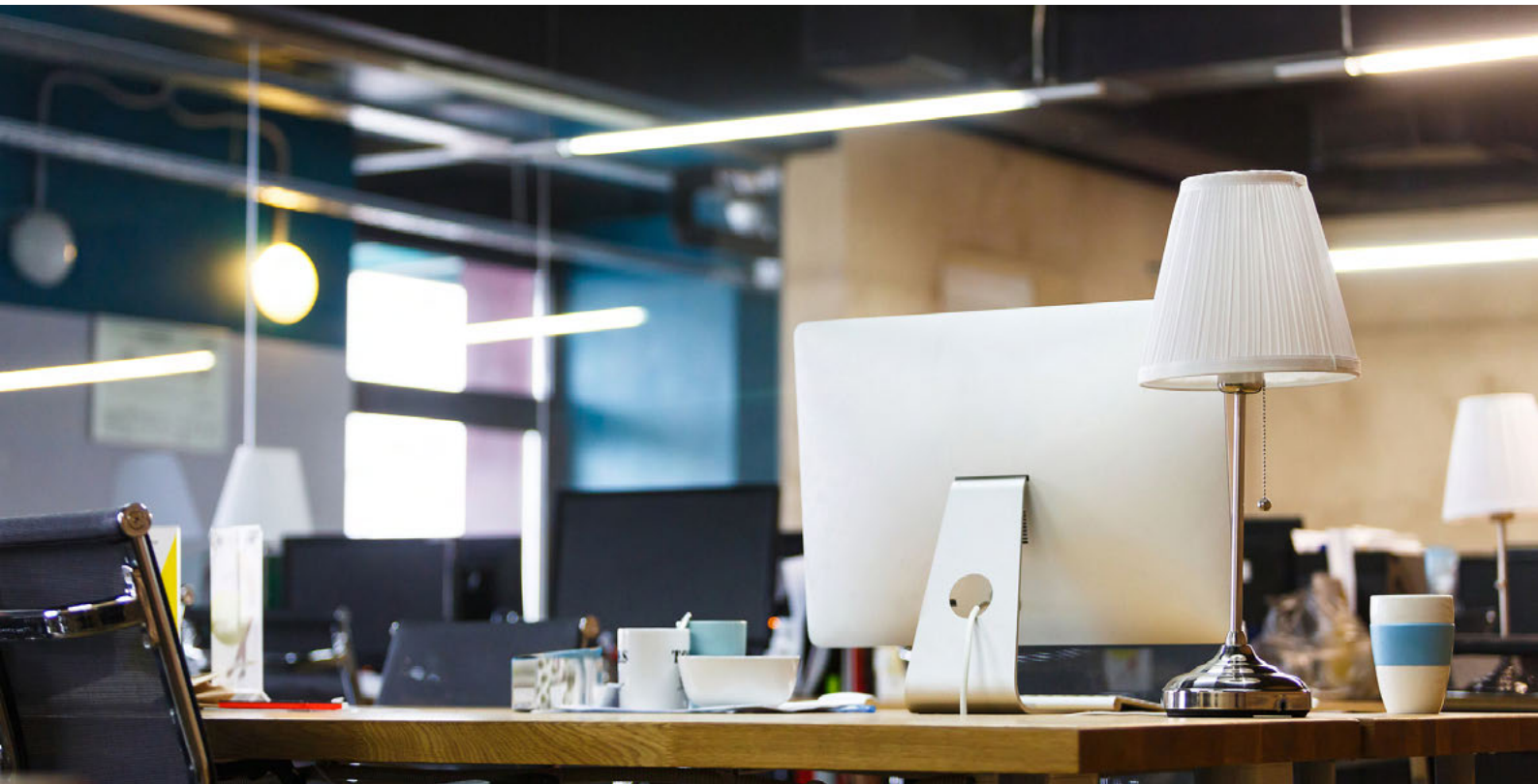

One of the many features of the Photius is that it emits flicker-free light helping to create a more comfortable lighting environment.

## Benefits of Flicker-Free Lighting

- Helps eliminate eye strain
- Improved light quality
- Helps reduce headaches and staff illness

## Excellent Cost Savings

With low wattage across the range, 35,000 hour life (20,000 for 3-hour emergency version) and 100,000 switching cycles, the Photius will save you money.

40W

Annual running cost

£14.69

60W

Annual running cost

£22.03

All above figures are based on annual usage 7hrs/day @ £0.1437kWhr

Crompton Lamps Limited  
Unit 2  
Marrtree Business Park  
Bowling Back Lane  
Bradford  
BD4 8QE

Tel: 01274 657 088  
Fax: 01274 657 087

Email: [sales@cromptonlamps.com](mailto:sales@cromptonlamps.com)  
[www.cromptonlamps.com](http://www.cromptonlamps.com)

Trade Descriptions: All descriptions represent only particulars of the goods to which they apply and do not form part of any contract. Due to policy of continuous development and improvement, Crompton Lamps Limited reserves the right to change the specification and performance data of the products listed without prior notice or public announcement.

# Suspension and Surface Mountable

The Photius has a sleek, slim style and compact design with a height of just 36mm and is suitable for suspension (suspension kit included) or surface mounting.

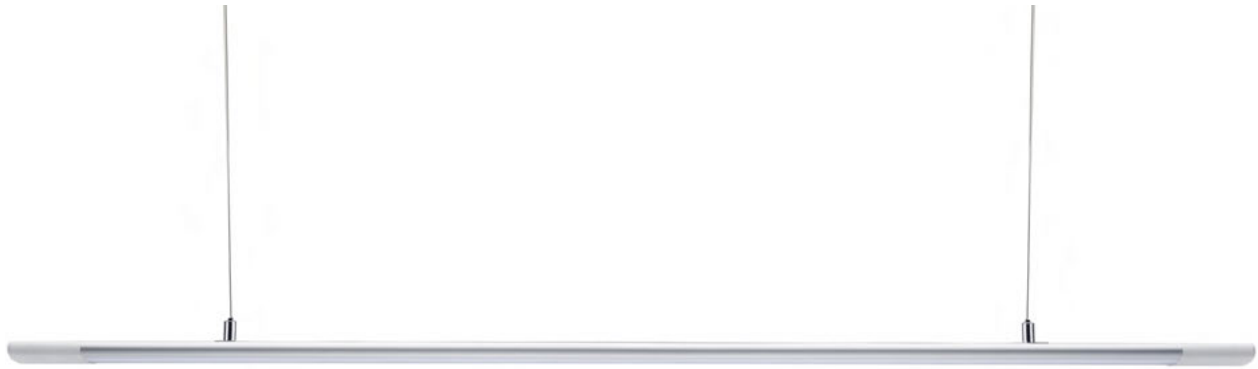

High Efficiency  
**120lm/W**

**IP42**  
Rating

## Anodized Aluminium Construction

Features an anodized aluminium construction to produce a decorative, robust, non-corrosive body with a polycarbonate diffuser.



Crompton Lamps Limited  
Unit 2  
Marrtree Business Park  
Bowling Back Lane  
Bradford  
BD4 8QE

Tel: 01274 657 088  
Fax: 01274 657 087

Email: [sales@cromptonlamps.com](mailto:sales@cromptonlamps.com)  
[www.cromptonlamps.com](http://www.cromptonlamps.com)

**Trade Descriptions:** All descriptions represent only particulars of the goods to which they apply and do not form part of any contract. Due to policy of continuous development and improvement, Crompton Lamps Limited reserves the right to change the specification and performance data of the products listed without prior notice or public announcement.

# Technical Information

## 40W and 60W Photius Integrated CCT



- 35,000 hour life (20,000 for emergency version)
- 100,000 switching cycles
- 120° beam angle
- 3000K/4000K/6000K tri-colour select
- High efficiency 120lm/W
- Colour rendering index  $\geq 80$
- IP42 rated
- For indoor use only
- Not suitable for dimming
- 5 year warranty

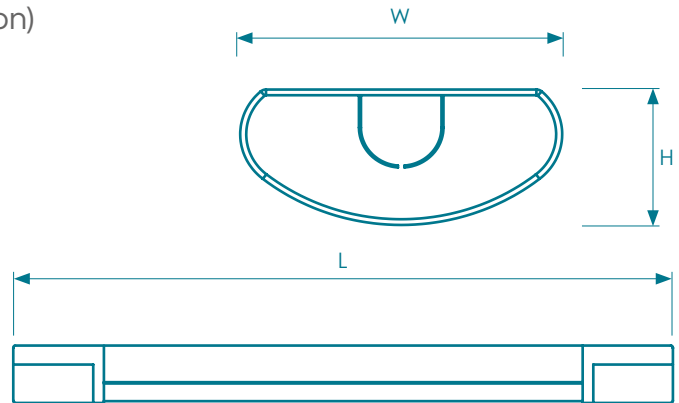

Product Code	Watts (W)	Volts (V)	Product Description	Colour Temp (K)	Total Lumens (lm)	Beam Angle	Dimensions (mm)			Order Qty
							W	H	L	
<b>Standard - Single Carton</b>										
12219	40	240	4ft Integrated CCT	3000/4000/6000	4800	120°	80	36	1190	1
12240	60	240	5ft Integrated CCT	3000/4000/6000	7200	120°	80	36	1490	1
<b>Microwave Sensor - Single Carton</b>										
12226	40	240	4ft Integrated CCT	3000/4000/6000	4800	120°	80	36	1190	1
12257	60	240	5ft Integrated CCT	3000/4000/6000	7200	120°	80	36	1490	1
<b>3-Hour Emergency - Single Carton</b>										
12233	40	240	4ft Integrated CCT	3000/4000/6000	4800	120°	80	36	1190	1
12264	60	240	5ft Integrated CCT	3000/4000/6000	7200	120°	80	36	1490	1

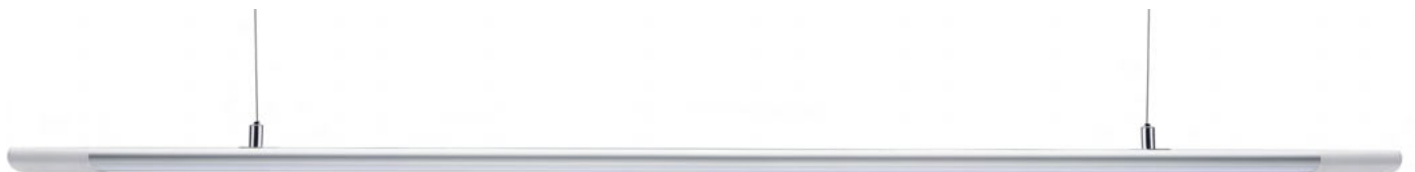
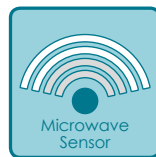
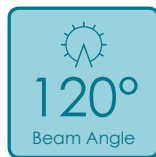

Crompton Lamps Limited  
 Unit 2  
 Marrtree Business Park  
 Bowring Back Lane  
 Bradford  
 BD4 8QE

Tel: 01274 657 088  
 Fax: 01274 657 087

Email: [sales@cromptonlamps.com](mailto:sales@cromptonlamps.com)  
[www.cromptonlamps.com](http://www.cromptonlamps.com)

**Trade Descriptions:** All descriptions represent only particulars of the goods to which they apply and do not form part of any contract. Due to policy of continuous development and improvement, Crompton Lamps Limited reserves the right to change the specification and performance data of the products listed without prior notice or public announcement.





Other fantastic Phoebe LED products that may interest you...

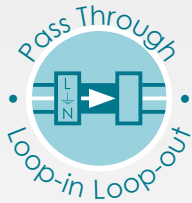

### Manto Integrated 2 LED Luminaire

The Manto 2 is an IP65 integrated LED fitting. It is available in standard and high output in 4ft and 5ft lengths with the choice of standard, microwave sensor and 3-hour emergency options. It has been designed with easy installation in mind and features two tool-less, loop-through terminal blocks.

## Visit our website and view our full range of lamps and fittings

### Benefits of signing up:

- Online ordering
- Special offers
- Check stock and prices
- View order history
- Detailed product information
- View our comprehensive range



Crompton Lamps Limited  
 Unit 2  
 Marrtree Business Park  
 Bowling Back Lane  
 Bradford  
 BD4 8QE

Tel: 01274 657 088  
 Fax: 01274 657 087  
 Email: sales@cromptonlamps.com  
 www.cromptonlamps.com



Design and production by Marketing,  
 Crompton Lamps Limited  
 E. & O. E. © Crompton Lamps Limited 2019.  
 All rights reserved.

