

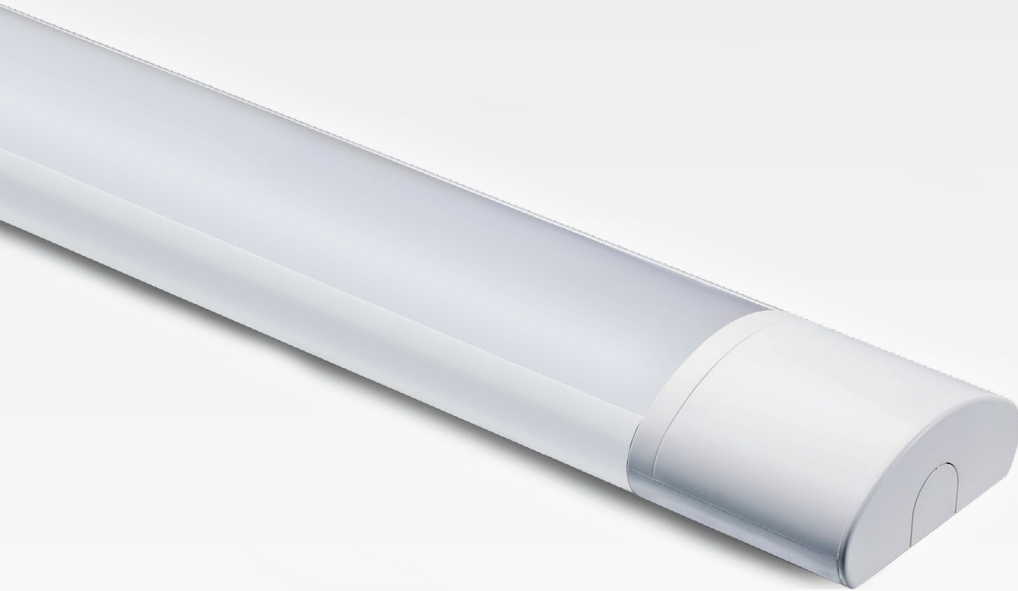

PHOTIUS
INTEGRATED CCT

PHOEBE LED PHOTIUS INTEGRATED CCT

Features CCT Technology and Slim Design



Standard, Microwave Sensor and Emergency Models Available

- Features CCT technology
- 3000K/4000K/6000K tri-colour select
- 4ft/5ft length options
- Suspension kit included



40W and 60W Photius Integrated CCT

The Photius Integrated LED CCT batten features CCT technology allowing the colour temperature to be quickly changed between 3000K, 4000K and 6000K with its easy access switch.

It is available in 4ft and 5ft lengths with a choice of standard, microwave sensor and 3-hour emergency models.

With a slim-line, stylish design and flicker-free light output, the Photius is ideally suited for a variety of indoor commercial applications.

- 35,000 hour life (20,000 for emergency version)
- 100,000 switching cycles
- 120° beam angle
- 3000K/4000K/6000K tri-colour select
- High efficiency 120lm/W
- Colour rendering index ≥ 80
- IP42 rated
- For indoor use only
- Not suitable for dimming
- 5 year warranty



Adaptable, Stylish and Reliable

Developed and designed to be the ideal solution for settings such as offices, residential, commercial and other lighting applications where dependability and quality light are required.



Crompton Lamps Limited
Unit 2
Marrtree Business Park
Bawling Back Lane
Bradford
BD4 8QE

Tel: 01274 657 088
Fax: 01274 657 087

Email: sales@cromptonlamps.com
www.cromptonlamps.com

Trade Descriptions: All descriptions represent only particulars of the goods to which they apply and do not form part of any contract. Due to policy of continuous development and improvement, Crompton Lamps Limited reserves the right to change the specification and performance data of the products listed without prior notice or public announcement.

3-Hour Emergency Model

- Discharge \geq 3 Hours at 960lm
- 24 hour Charge Time
- Built-in Emergency Test Function

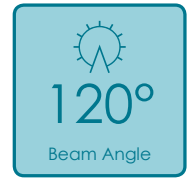

Microwave Sensor Model

- 6m Max Detection Range
- 5secs - 10min Hold Time
- 120° Detection Angle
- Light output turns off or dims to 20% when sensor not triggered
- Easy access module for quick adjustment to sensor settings

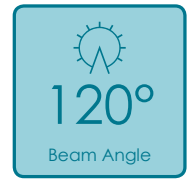
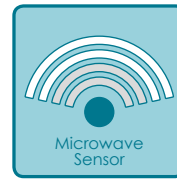

Quick and Easy Installation

The Photius features a 3-way terminal block to ensure installation is quick and simple. Emergency model has a 4-way terminal block with continuous live feed.

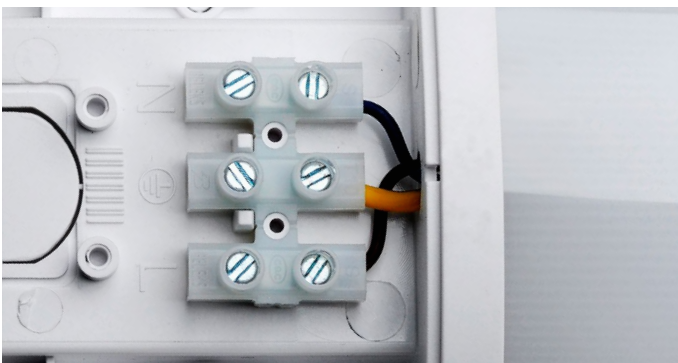

Standard and Microwave Sensor model terminal block.

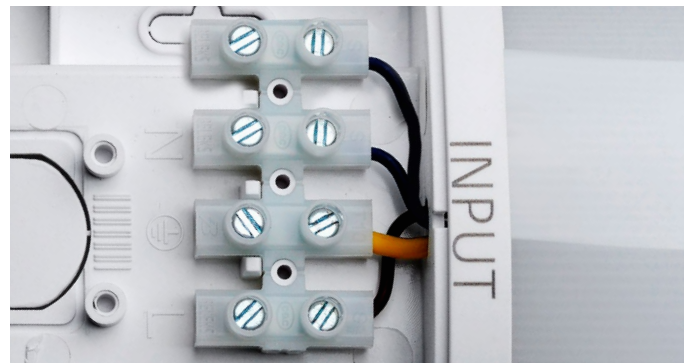

3-Hour Emergency model terminal block.

Crompton Lamps Limited
Unit 2
Marrtree Business Park
Bowling Back Lane
Bradford
BD4 8QE

Tel: 01274 657 088
Fax: 01274 657 087

Email: sales@cromptonlamps.com
www.cromptonlamps.com

Trade Descriptions: All descriptions represent only particulars of the goods to which they apply and do not form part of any contract. Due to policy of continuous development and improvement, Crompton Lamps Limited reserves the right to change the specification and performance data of the products listed without prior notice or public announcement.

Tri-Colour Selection

A key function of the Photius is the option to switch the colour temperature between 3000K, 4000K and 6000K.

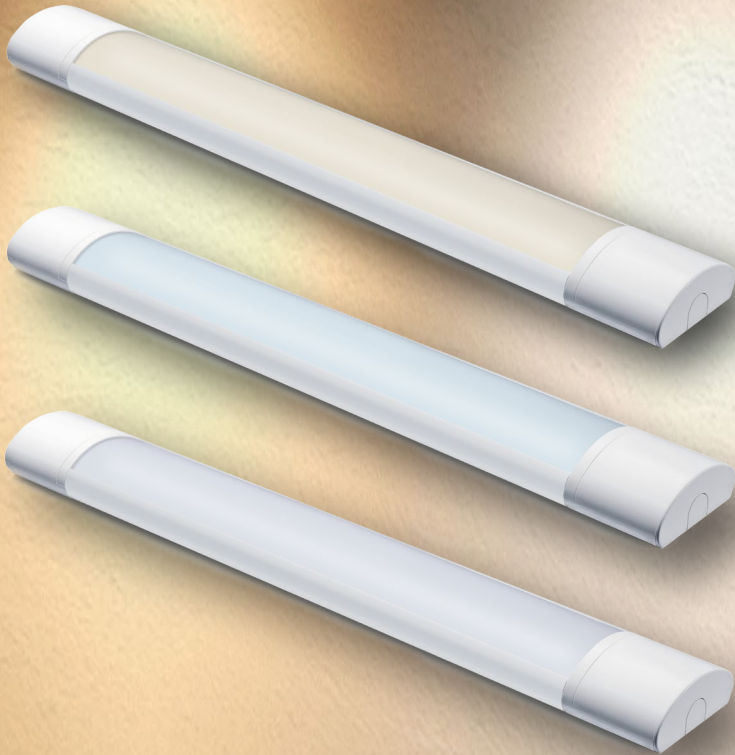

3000K
WARM WHITE

4000K
COOL WHITE

6000K
DAYLIGHT



Easy Access Switch

Changing the colour temperature is quick and simple thanks to the easy access switch.



Crompton Lamps Limited
Unit 2
Marrtree Business Park
Bowling Back Lane
Bradford
BD4 8QE

Tel: 01274 657 088
Fax: 01274 657 087

Email: sales@cromptonlamps.com
www.cromptonlamps.com

Trade Descriptions: All descriptions represent only particulars of the goods to which they apply and do not form part of any contract. Due to policy of continuous development and improvement, Crompton Lamps Limited reserves the right to change the specification and performance data of the products listed without prior notice or public announcement.

Eliminates Visible Flicker



One of the many features of the Photius is that it emits flicker-free light helping to create a more comfortable lighting environment.

Benefits of Flicker-Free Lighting

- Helps eliminate eye strain
- Improved light quality
- Helps reduce headaches and staff illness

Excellent Cost Savings

With low wattage across the range, 35,000 hour life (20,000 for 3-hour emergency version) and 100,000 switching cycles, the Photius will save you money.

40W

Annual running cost

£14.69

60W

Annual running cost

£22.03

All above figures are based on annual usage 7hrs/day @ £0.1437kWhr

Crompton Lamps Limited
Unit 2
Marrtree Business Park
Bowling Back Lane
Bradford
BD4 8QE

Tel: 01274 657 088
Fax: 01274 657 087

Email: sales@cromptonlamps.com
www.cromptonlamps.com

Trade Descriptions: All descriptions represent only particulars of the goods to which they apply and do not form part of any contract. Due to policy of continuous development and improvement, Crompton Lamps Limited reserves the right to change the specification and performance data of the products listed without prior notice or public announcement.

Suspension and Surface Mountable

The Photius has a sleek, slim style and compact design with a height of just 36mm and is suitable for suspension (1 meter suspension kit included) or surface mounting.

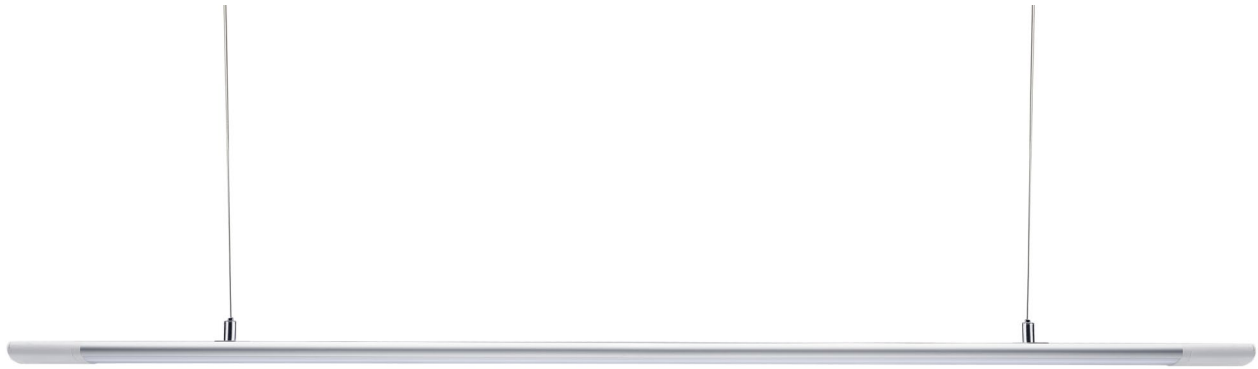

High Efficiency

120lm/W

IP42
Rating

Anodized Aluminium Construction

Features an anodized aluminium construction to produce a decorative, robust, non-corrosive body with a polycarbonate diffuser.



Crompton Lamps Limited
Unit 2
Marrtree Business Park
Bowling Back Lane
Bradford
BD4 8QE

Tel: 01274 657 088
Fax: 01274 657 087

Email: sales@cromptonlamps.com
www.cromptonlamps.com

Trade Descriptions: All descriptions represent only particulars of the goods to which they apply and do not form part of any contract. Due to policy of continuous development and improvement, Crompton Lamps Limited reserves the right to change the specification and performance data of the products listed without prior notice or public announcement.

Technical Information

40W and 60W Photius Integrated CCT



- 35,000 hour life (20,000 for emergency version)
- 100,000 switching cycles
- 120° beam angle
- 3000K/4000K/6000K tri-colour select
- High efficiency 120lm/W
- Colour rendering index ≥ 80
- IP42 rated
- For indoor use only
- Not suitable for dimming
- 5 year warranty

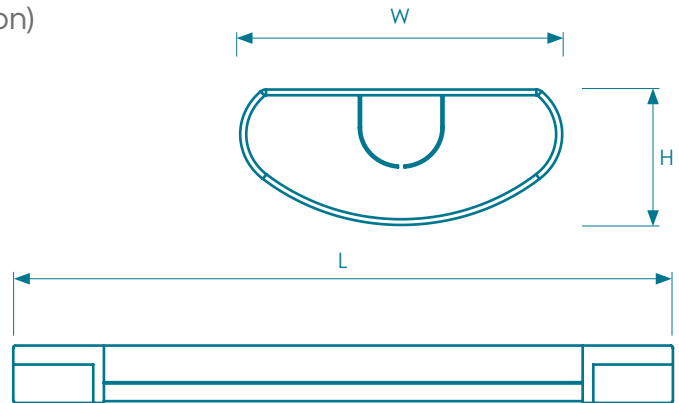

Product Code	Watts (W)	Volts (V)	Product Description	Colour Temp (K)	Total Lumens (lm)	Beam Angle	Dimensions (mm)			Order Qty
							W	H	L	
Standard - Single Carton										
12219	40	240	4ft Integrated CCT	3000/4000/6000	4800	120°	80	36	1190	1
12240	60	240	5ft Integrated CCT	3000/4000/6000	7200	120°	80	36	1490	1
Microwave Sensor - Single Carton										
12226	40	240	4ft Integrated CCT	3000/4000/6000	4800	120°	80	36	1190	1
12257	60	240	5ft Integrated CCT	3000/4000/6000	7200	120°	80	36	1490	1
3-Hour Emergency - Single Carton										
12233	40	240	4ft Integrated CCT	3000/4000/6000	4800	120°	80	36	1190	1
12264	60	240	5ft Integrated CCT	3000/4000/6000	7200	120°	80	36	1490	1

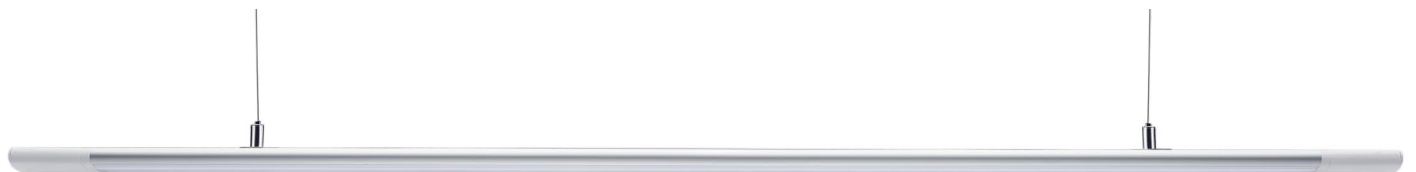
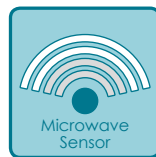
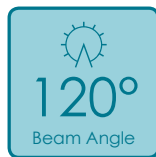

Crompton Lamps Limited
 Unit 2
 Marrtree Business Park
 Bowring Back Lane
 Bradford
 BD4 8QE

Tel: 01274 657 088
 Fax: 01274 657 087

Email: sales@cromptonlamps.com
www.cromptonlamps.com

Trade Descriptions: All descriptions represent only particulars of the goods to which they apply and do not form part of any contract. Due to policy of continuous development and improvement, Crompton Lamps Limited reserves the right to change the specification and performance data of the products listed without prior notice or public announcement.



ORDER

DESPATCH

RECEIVE

NEW



Carriage Paid Price

£195

Minimum order value of £195 for carriage paid delivery to UK mainland destinations.

Orders under £195 will be subject to a £10.00 small order charge.

Please contact our customer service team for minimum order values and delivery prices to non-UK mainland destinations.

NEW



Same Day Despatch

Order **Monday - Friday** before **4pm** for **Same Day** despatch*.

*We endeavour to despatch all orders received Monday - Friday before 4pm the same day.

NEW



Next Day Delivery

All UK mainland orders will be despatched by our **Next Day** delivery service*.

*95% of orders are delivered the next working day. For customers requiring guaranteed next working day delivery, an extra charge will be applied. Please contact our customer service team for guaranteed next day delivery options and prices.

The above information does not include weekend delivery. Please contact our customer service team if you require a quotation for Saturday delivery.

Visit our website and view our full range of lamps and fittings

Benefits of signing up:

- Online ordering
- Check stock and prices
- View order history
- Detailed product information
- View our comprehensive range



Crompton Lamps Limited registered in England and Wales No: 05590551

Crompton Lamps Limited
Unit 2
Marrtree Business Park
Bowling Back Lane
Bradford
BD4 8QE

Tel: 01274 657 088
Fax: 01274 657 087
Email: sales@cromptonlamps.com



www.cromptonlamps.com



Design and production by Marketing,
Crompton Lamps Limited
E. & O. E. © Crompton Lamps Limited 2019.
All rights reserved.