

**ATLANTA  
LED  
DOWNLIGHT**

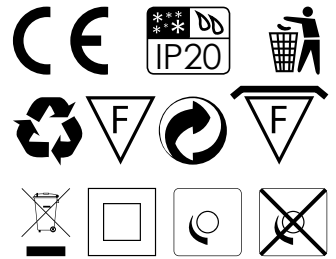

This instruction sheet is relevant to Phoebe LED Atlanta Downlight part codes: 10536, 10543, 12172, 12189, 12196 & 12202

**THANK YOU for buying this PHOEBE LED product.** To help ensure this luminaire gives complete satisfaction please only use it according to the following instructions, and then pass the instructions to the appropriate person for retention and future reference.

**Warning**

1. Installation only to be carried out by a qualified electricians
  2. Please ensure surface is suitable and capable of holding the lamp weight
  3. Do not operate if product is damaged
  4. This product is not suitable for fire rated installations
- The light source of this luminaire is not replaceable; when the light source reaches it's end of life the whole luminaire should be replaced

**Environmental Protection**  
Waste electrical products should not be disposed of with household waste. Please recycle where facilities exist.  
Check with your Local Authority or retailer for recycling advice.

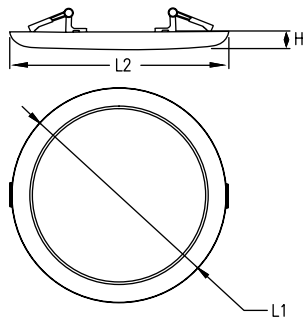

Product code	Power (W)	Dimensions (mm)			
		L1	L2	H	(optional)
<b>12172 / 12189</b>	6.5	Ø120	Ø120	15	Ø63.5-102 (2.5-4 Inch)
<b>10536 / 10543</b>	18.5	Ø230	Ø230	15	Ø63.5-203.2 (2.5-8 Inch)
<b>12196 / 12202</b>	18.5	Ø230	Ø230	15	Ø63.5-203.2 (2.5-8 Inch)

**Atlanta Surface Mount Instructions**

- 1**
  - a. Switch off power
  - b. Use bracket to determine mounting location
  - c. Drill holes and insert the supplied raw-plugs
  - d. Fix the bracket onto the ceiling with the supplied screws

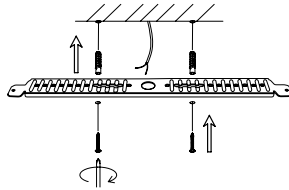

- 2**
  - a. Thread cable through center position on bracket and connect to mains using the pre-wired input cable according to current wiring regulations  
**Brown=Live Blue=Neutral**

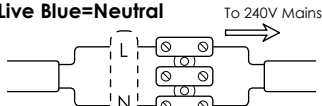

- b. Align luminaire with bracket, push and twist counter-clockwise to lock into position

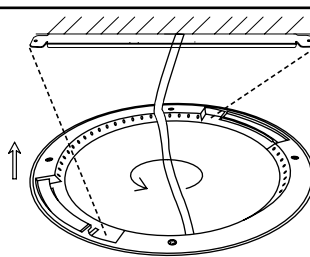

**Atlanta Recessed Mount Instructions**

- 1**
  - a. Switch off power
  - b. Use existing recess or pre cut a new hole correct to size (see table above)

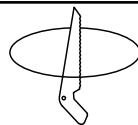

- 2** Thread cable through center position on bracket and connect to mains using the pre-wired input cable according to current wiring regulations

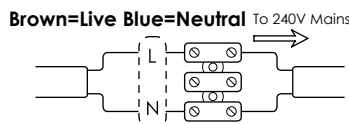

- 3**
  - a. Adjust bracket for recess size, locking points are marked every 0.5 inch. To increase the diameter simply push the clip springs away from the centre, the spring will lock into position
  - b. To decrease the diameter lift out the locking spring and pull towards the centre, then let go of the locking spring and adjust outwards to desired position as step 3a.
  - c. Align luminaire with bracket, push and twist counter-clockwise to lock into position

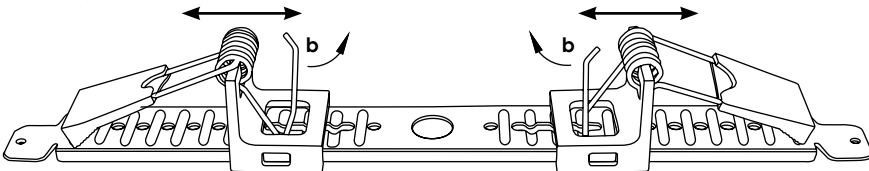

**BEFORE YOU START PLEASE READ ALL THE INSTRUCTIONS CAREFULLY**

**PRIOR TO INSTALLATION**

Turn power off at the mains

**ONLY ONCE INSTALLATION IS COMPLETE**

Turn power back on at the mains

**CIRCUIT TESTING**

For high voltage circuit insulation testing disconnect mains input supply first  
**(Do not circuit test using a Megger)**

- 4**
  - a. Push back spring clips and insert luminaire into recess.
  - b. Ensure luminaire is a flush fit and has plenty of ventilation, do not cover with insulating material

Images are for information only. Phoebe LED shall not be held liable for improper operation of the luminaire in circumstances where procedures and specifications have not been followed correctly. Crompton Lamps Limited 2018