



## PHOEBE LED MANTO INTEGRATED 2 LED LUMINAIRE

Featuring Two Tool-Less, Loop-Through Terminal Blocks with Continuous Live Feed



Standard, Microwave Sensor and Emergency Models Available

- Loop-through continuous live feed
- IP65 rated for outdoor use
- High output options
- Non-corrosive



# Non-Corrosive IP65 Integrated LED Fitting

The Manto 2 is an IP65 integrated LED fitting. It is available in standard and high output in 4ft and 5ft lengths with the choice of microwave sensor and 3 hour emergency options.

It has been designed with easy installation in mind and features two tool-less, loop-through terminal blocks with continuous live feed.

Constructed with an IK07 impact rated, moisture and acid resistant ABS body with Polycarbonate diffuser, the Manto 2 has been developed to be robust, durable and is suitable for conduit, surface, or suspension mounting.

- 50,000 hour life
- 100,000 switching cycles
- Loop-through continuous live feed
- 120° beam angle
- 4000K colour temperature
- Colour rendering index  $\geq 80$
- IP65 rated
- Internal terminal block for safety
- IK07 impact rating
- 5 year warranty

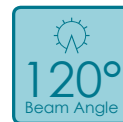
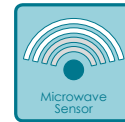
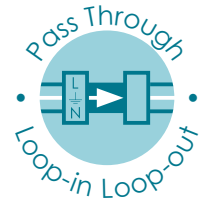

## Durability, Reliability & Easy Installation

Developed and designed to be the ideal solution for industrial applications such as car parks, garages and workshops where quality, dependability and hassle free installation is required.



Crompton Lamps Limited  
Unit 2  
Marrtree Business Park  
Bowling Back Lane  
Bradford  
BD4 8QE

Tel: 01274 657 088  
Fax: 01274 657 087

Email: [sales@cromptonlamps.com](mailto:sales@cromptonlamps.com)  
[www.cromptonlamps.com](http://www.cromptonlamps.com)

**Trade Descriptions:** All descriptions represent only particulars of the goods to which they apply and do not form part of any contract. Due to policy of continuous development and improvement, Crompton Lamps Limited reserves the right to change the specification and performance data of the products listed without prior notice or public announcement.

# Fully IP65 Rated



One of the many key features of the Manto 2 is its IP65 rating. This rating ensures the Manto 2 can be utilised in a variety of wet conditions.

## Benefits of an IP65 rating

- Protected against water in all directions
- Suitable for wet weather outdoor use
- Complete protection against contact dust

## Excellent Cost Savings

With low wattages across the range, 50,000 hour life and 100,000 switching cycles, the Manto 2 will save you money.

20W  
Annual running cost

**£7.34**

30W  
Annual running cost

**£11.01**

40W  
Annual running cost

**£14.69**

60W  
Annual running cost

**£22.03**

All above figures are based on annual usage 7hrs/day @ £0.1437kWhr

# IK07

Impact rating

Crompton Lamps Limited  
Unit 2  
Marrtree Business Park  
Bowling Back Lane  
Bradford  
BD4 8QE

Tel: 01274 657 088  
Fax: 01274 657 087

Email: [sales@cromptonlamps.com](mailto:sales@cromptonlamps.com)  
[www.cromptonlamps.com](http://www.cromptonlamps.com)

**Trade Descriptions:** All descriptions represent only particulars of the goods to which they apply and do not form part of any contract. Due to policy of continuous development and improvement, Crompton Lamps Limited reserves the right to change the specification and performance data of the products listed without prior notice or public announcement.

# Loop-Through Continuous Live Feed

What makes the Manto 2 stand out from the competition is the key ability to have a continuous live feed from fitting-to-fitting thanks to its two loop-through terminal blocks. This unique feature saves any electrician/contractor an enormous amount of time on projects that require multiple fittings to be installed.

## Benefits of Loop-In/Loop-Out

- Tool-less wiring connector
- Simplifies the installation process
- Reduces time required for installation
- Permanent live for use with emergency models

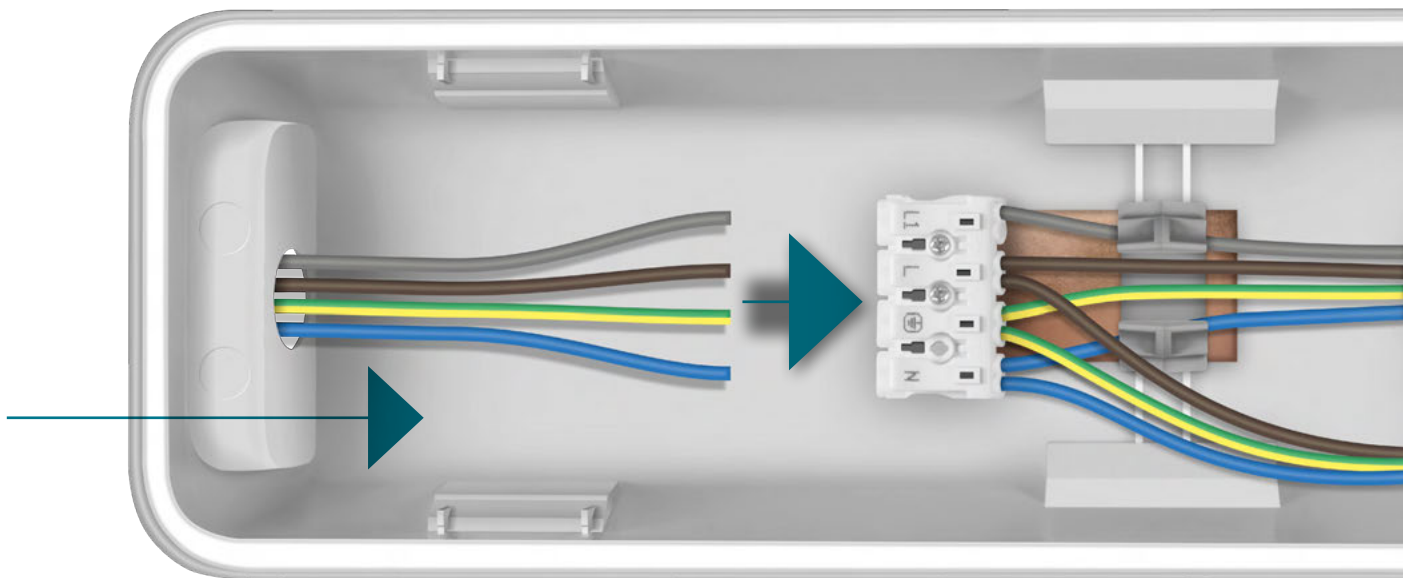

Loop through continuous live feed



The loop-in/loop-out terminals make it possible to wire from fitting-to-fitting

Crompton Lamps Limited  
Unit 2  
Marrtree Business Park  
Bowling Back Lane  
Bradford  
BD4 8QE

Tel: 01274 657 088  
Fax: 01274 657 087

Email: [sales@cromptonlamps.com](mailto:sales@cromptonlamps.com)  
[www.cromptonlamps.com](http://www.cromptonlamps.com)

**Trade Descriptions:** All descriptions represent only particulars of the goods to which they apply and do not form part of any contract. Due to policy of continuous development and improvement, Crompton Lamps Limited reserves the right to change the specification and performance data of the products listed without prior notice or public announcement.



High Output - Equivalent Replacement for Twin Fluorescent T8 Fittings

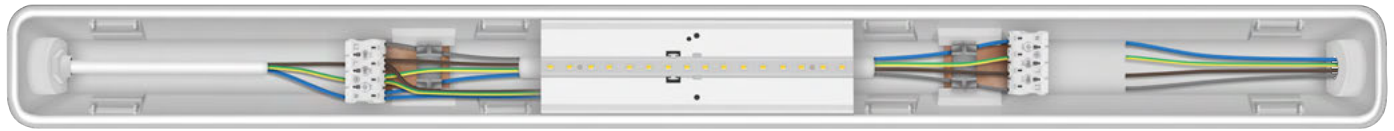

Standard - Equivalent Replacement for Single Fluorescent T8 Fittings

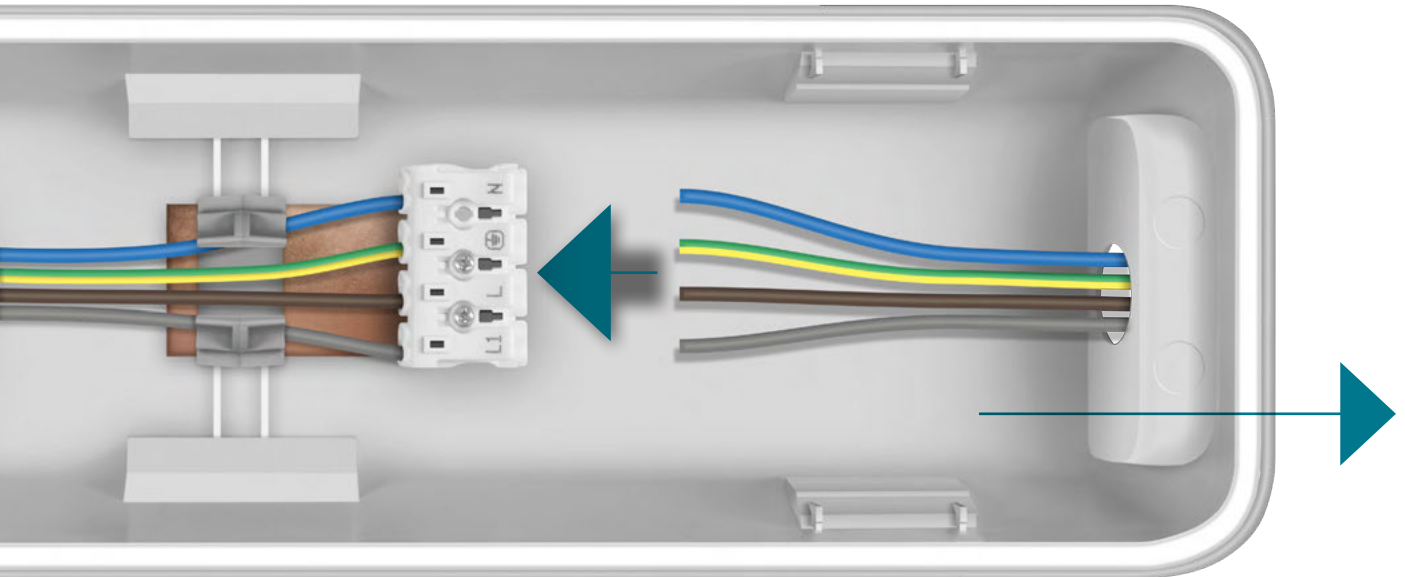

Crompton Lamps Limited  
 Unit 2  
 Marrtree Business Park  
 Bowling Back Lane  
 Bradford  
 BD4 8QE

Tel: 01274 657 088  
 Fax: 01274 657 087

Email: [sales@cromptonlamps.com](mailto:sales@cromptonlamps.com)  
[www.cromptonlamps.com](http://www.cromptonlamps.com)

**Trade Descriptions:** All descriptions represent only particulars of the goods to which they apply and do not form part of any contract. Due to policy of continuous development and improvement, Crompton Lamps Limited reserves the right to change the specification and performance data of the products listed without prior notice or public announcement.

## Microwave Sensor

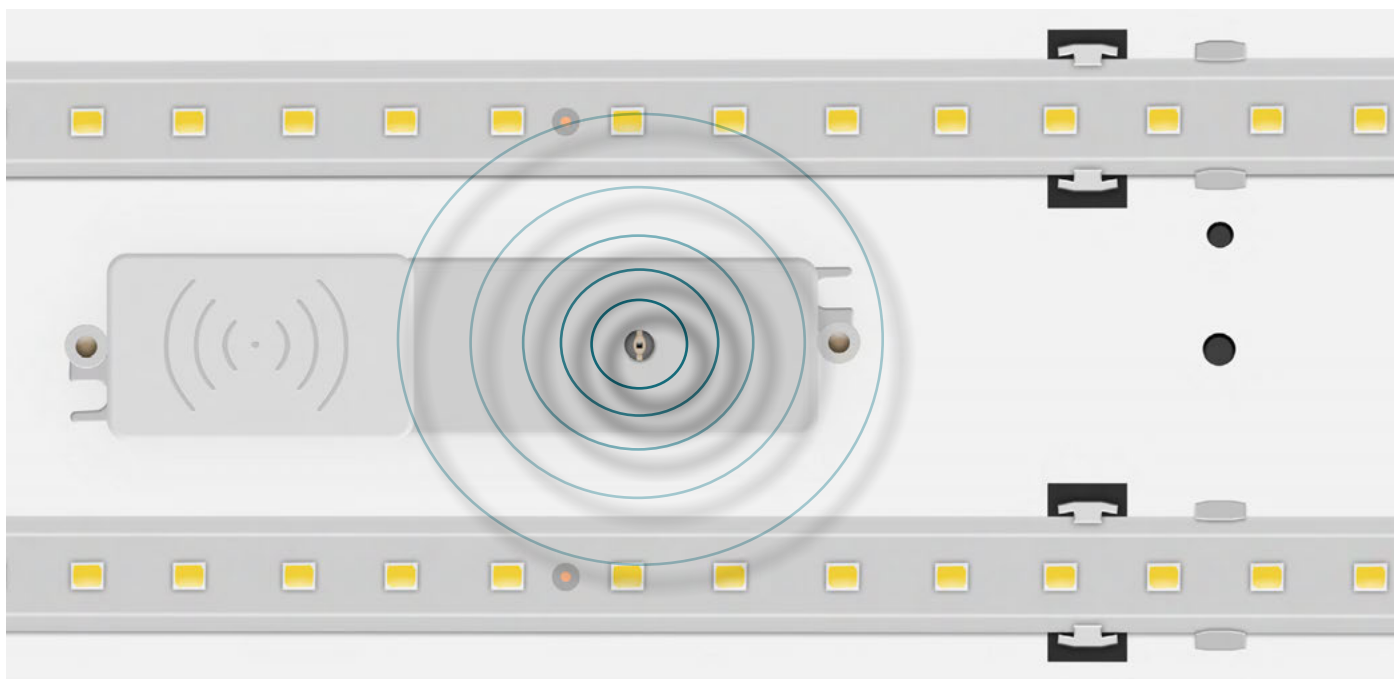

- 5m - 10m Detection Range
- 5secs - 10min Hold Time
- 2-2000lux Light Sensitivity
- Light output dims to 10% when sensor not triggered

## Emergency

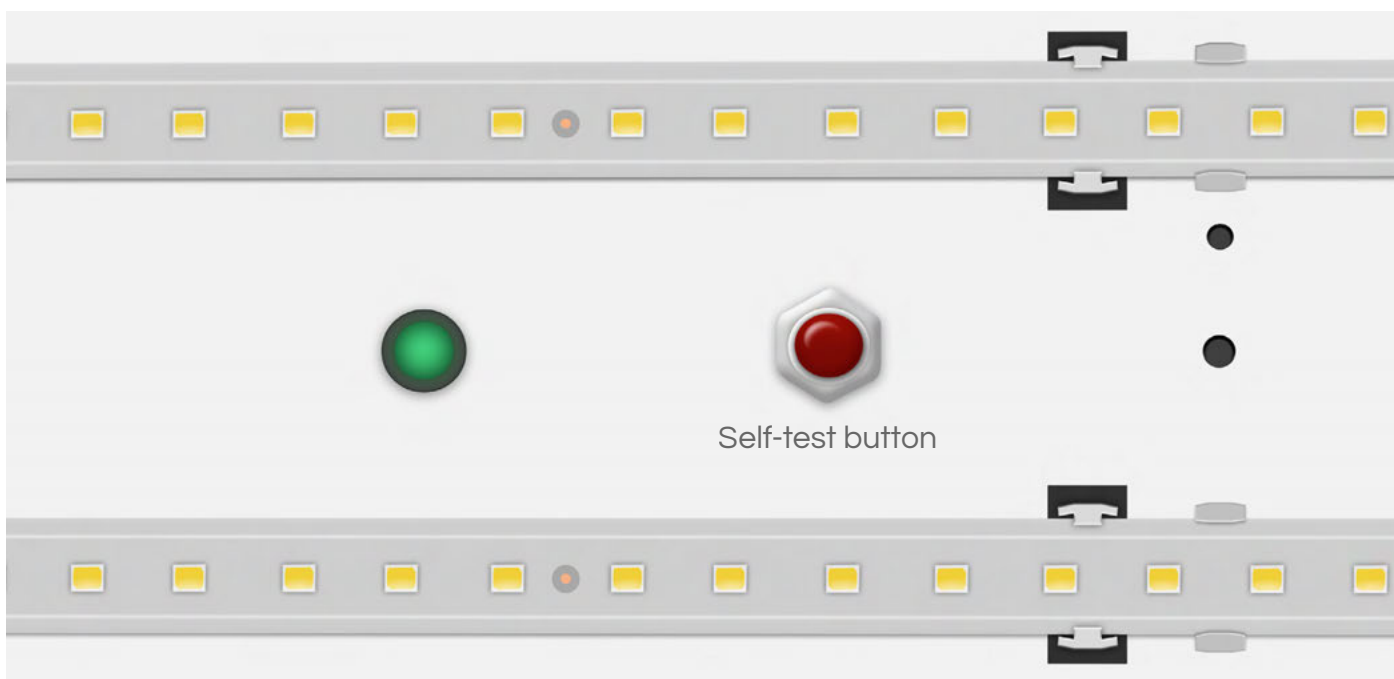

- Discharge  $\geq$  3 Hours
- 16 hour Charge Time

Crompton Lamps Limited  
Unit 2  
Marrtree Business Park  
Bowling Back Lane  
Bradford  
BD4 8QE

Tel: 01274 657 088  
Fax: 01274 657 087

Email: [sales@cromptonlamps.com](mailto:sales@cromptonlamps.com)  
[www.cromptonlamps.com](http://www.cromptonlamps.com)

**Trade Descriptions:** All descriptions represent only particulars of the goods to which they apply and do not form part of any contract. Due to policy of continuous development and improvement, Crompton Lamps Limited reserves the right to change the specification and performance data of the products listed without prior notice or public announcement.

# Technical Information



## Non-Corrosive IP65 Integrated LED Fitting

- 50,000 hour life
- 100,000 switching cycles
- Loop-through continuous live feed
- 120° beam angle
- 4000K colour temperature
- Colour rendering index  $\geq 80$
- IP65 rated
- Internal terminal block for safety
- IK07 impact rating
- 5 year warranty

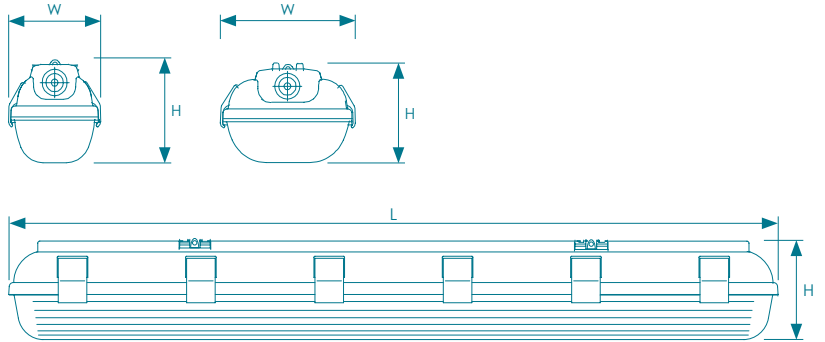

Product Code	Watts (W)	Volts (V)	Product Description	Colour Temp (K)	Total Lumens (lm)	Beam Angle	Dimensions (mm)			Order Qty
							W	H	L	
<b>4ft Standard - Single Carton</b>										
11021	20	240	4ft	4000K	2000	120°	85	75	1270	1
11038	20	240	4ft with Microwave Sensor	4000K	2000	120°	118	75	1270	1
11045	20	240	4ft with 3-Hour Emergency	4000K	2000	120°	85	75	1270	1
<b>4ft High Output - Single Carton</b>										
11052	40	240	4ft	4000K	4000	120°	118	75	1270	1
11069	40	240	4ft with Microwave Sensor	4000K	4000	120°	118	75	1270	1
11076	40	240	4ft with 3-Hour Emergency	4000K	4000	120°	118	75	1270	1
<b>5ft Standard - Single Carton</b>										
11083	30	240	5ft	4000K	3000	120°	85	75	1570	1
11090	30	240	5ft with Microwave Sensor	4000K	3000	120°	118	75	1570	1
11106	30	240	5ft with 3-Hour Emergency	4000K	3000	120°	85	75	1570	1
<b>5ft High Output - Single Carton</b>										
11113	60	240	5ft	4000K	6000	120°	118	75	1570	1
11120	60	240	5ft with Microwave Sensor	4000K	6000	120°	118	75	1570	1
11137	60	240	5ft with 3-Hour Emergency	4000K	6000	120°	118	75	1570	1

4000K  
Cool White

No Phosphors

Mercury Free

Suitable for Outdoor Use

Class I

3 Hour Emergency

Microwave Sensor

IP65  
IP Rating

IK07  
Impact Rating

120°  
Beam Angle

Non-Dimmable

5 YEAR  
LED LIMITED WARRANTY

Crompton Lamps Limited  
Unit 2  
Marrtree Business Park  
Bowling Back Lane  
Bradford  
BD4 8QE

Tel: 01274 657 088  
Fax: 01274 657 087

Email: sales@cromptonlamps.com  
www.cromptonlamps.com

**Trade Descriptions:** All descriptions represent only particulars of the goods to which they apply and do not form part of any contract. Due to policy of continuous development and improvement, Crompton Lamps Limited reserves the right to change the specification and performance data of the products listed without prior notice or public announcement.



Other fantastic Phoebe LED products that may interest you...



PHOTIUS

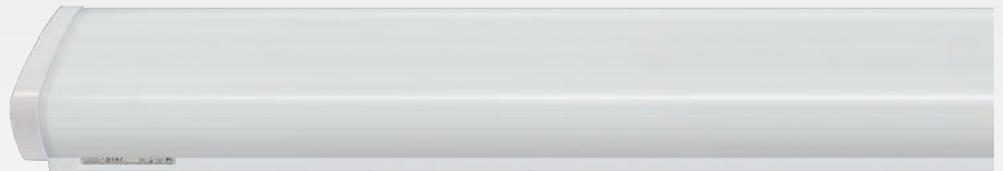

### Photius T8 Batten

Robust steel T8 batten pre-wired to mains (240V) for use with Crompton Lamps LED T8 tubes only. Constructed from a robust steel body with white gloss powder coated finish, polycarbonate end caps and fused terminal block for safety.

## Visit our website and view our full range of lamps and fittings

### Benefits of signing up:

- Online ordering
- Special offers
- Check stock and prices
- View order history
- Detailed product information
- View our comprehensive range



Crompton Lamps Limited  
 Unit 2  
 Marrtree Business Park  
 Bowling Back Lane  
 Bradford  
 BD4 8QE

Tel: 01274 657 088  
 Fax: 01274 657 087  
 Email: sales@cromptonlamps.com  
 www.cromptonlamps.com



Design and production by Marketing,  
 Crompton Lamps Limited  
 E. & O. E. © Crompton Lamps Limited 2019.  
 All rights reserved.

