



## PHOEBE LED FIRESAFE DOWNLIGHT

All-In-One Dimmable Downlight with Insulation Guards



Features Tri-Colour Selection and Interchangeable Bezels

- Tri-colour selection
- Fully dimmable
- 30, 60 and 90 minute fire-rated
- Interchangeable bezels



## 8.5W All-In-One Fire-Rated Dimmable Downlight

The all-in-one Firesafe LED Downlight is fully dimmable and IP65 rated. It features insulation guards and an easy access front-facing tri-colour selection switch (behind the front bezel) with a colour choice of 3000K, 4000K or 6500K.

It includes two stylish interchangeable bezels, white and brushed nickel effect with an optional chrome effect third bezel.

Designed with easy installation in mind, it features a constant current driver with fitting-to-fitting loop-in/loop-out tool-less wiring connector.

- 30, 60 and 90 minute fire-rated
- 3000K, 4000K, 6500K tri-colour select
- Suitable for dimming
- IP65 rated
- 50,000 hour life
- 100,000 switching cycles
- 60° beam angle



## Style, Safety and Versatility

Developed and designed to combine style, safety and versatility, the Firesafe is the perfect solution for both commercial and domestic applications.



Crompton Lamps Limited  
Unit 2  
Marrtree Business Park  
Bowling Back Lane  
Bradford  
BD4 8QE

Tel: 01274 657 088  
Fax: 01274 657 087

Email: [sales@cromptonlamps.com](mailto:sales@cromptonlamps.com)  
[www.cromptonlamps.com](http://www.cromptonlamps.com)

**Trade Descriptions:** All descriptions represent only particulars of the goods to which they apply and do not form part of any contract. Due to policy of continuous development and improvement, Crompton Lamps Limited reserves the right to change the specification and performance data of the products listed without prior notice or public announcement.

## Compact Design

The Firesafe features a compact design with a total height of just 65mm (When guards are in down position) and a diameter of 89mm.

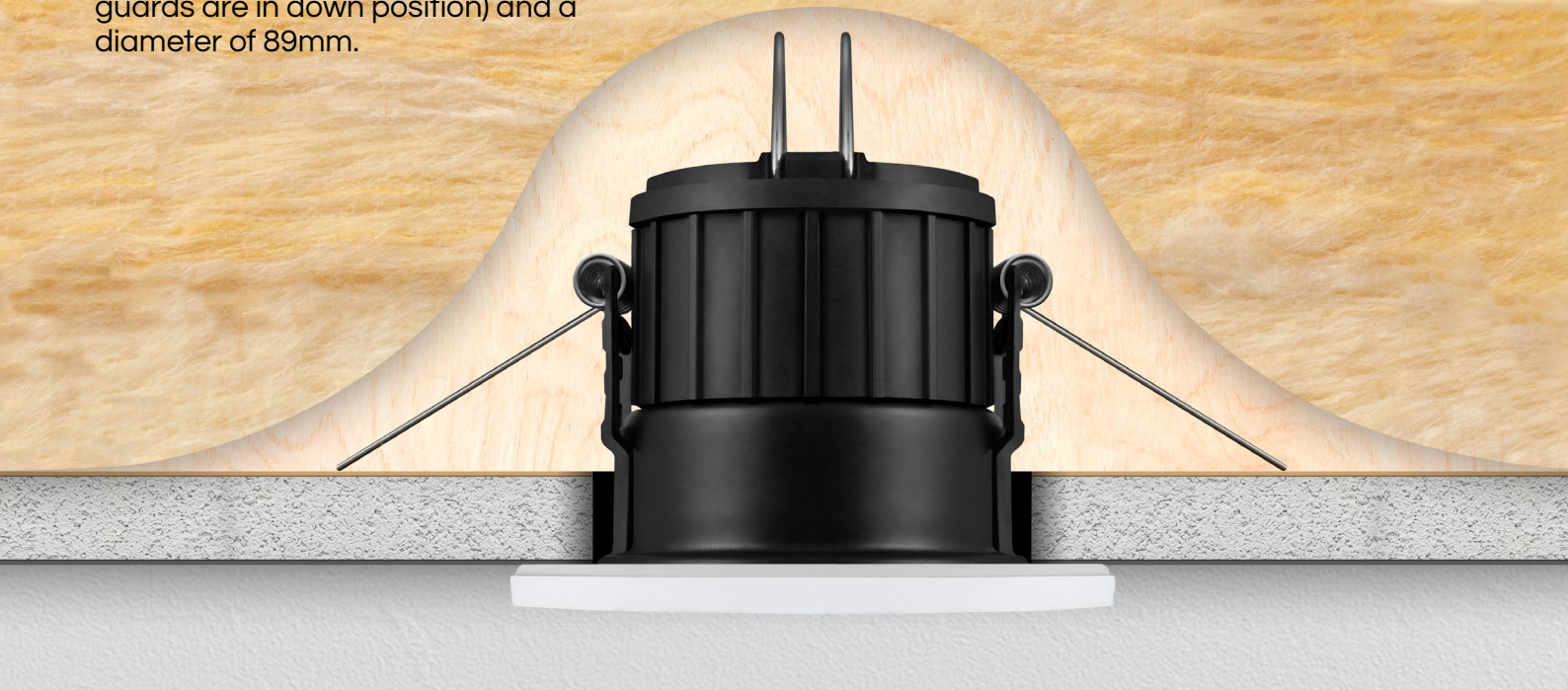

## Insulation Guards

The adjustable guards prevent the Firesafe from being covered by insulation, improving ventilation and increasing safety.

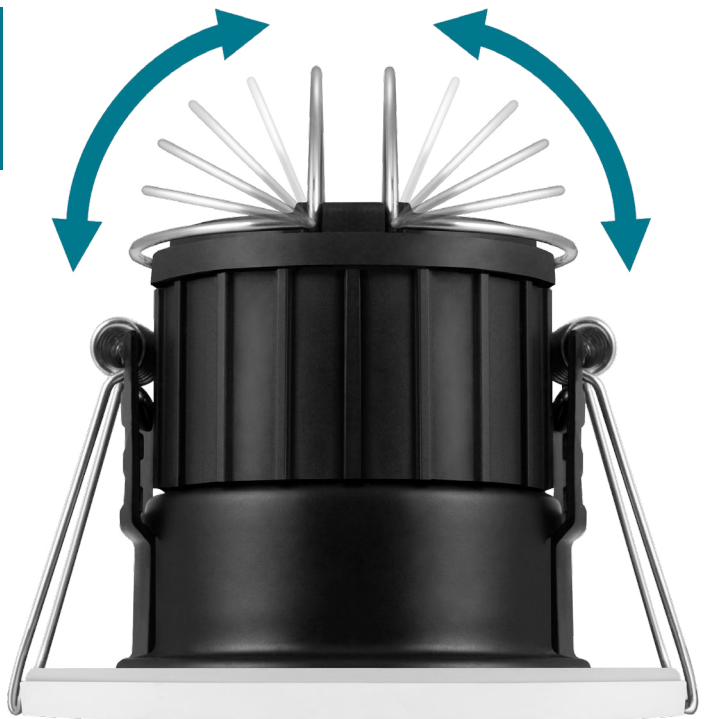

Crompton Lamps Limited  
Unit 2  
Marrtree Business Park  
Bowling Back Lane  
Bradford  
BD4 8QE

Tel: 01274 657 088  
Fax: 01274 657 087

Email: [sales@cromptonlamps.com](mailto:sales@cromptonlamps.com)  
[www.cromptonlamps.com](http://www.cromptonlamps.com)

**Trade Descriptions:** All descriptions represent only particulars of the goods to which they apply and do not form part of any contract. Due to policy of continuous development and improvement, Crompton Lamps Limited reserves the right to change the specification and performance data of the products listed without prior notice or public announcement.



## Tri-Colour Selection

3000K  
WARM WHITE

4000K  
COOL WHITE

6500K  
DAYLIGHT



## Easy Access Switch

A key Firesafe feature is the easy-access switch behind the twist-on front bezel enabling the colour temperature to be quickly changed.

## Interchangeable Bezels

Each Firesafe is supplied with twist-on interchangeable stylish bezels to complement various decor styles.



White

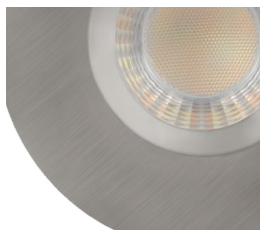

Brushed Nickel

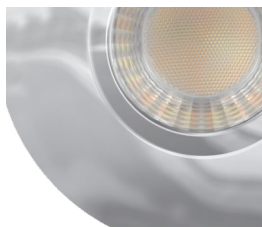

Optional Chrome Bezel



Crompton Lamps Limited  
Unit 2  
Marrtree Business Park  
Bowling Back Lane  
Bradford  
BD4 8QE

Tel: 01274 657 088  
Fax: 01274 657 087

Email: [sales@cromptonlamps.com](mailto:sales@cromptonlamps.com)  
[www.cromptonlamps.com](http://www.cromptonlamps.com)

**Trade Descriptions:** All descriptions represent only particulars of the goods to which they apply and do not form part of any contract. Due to policy of continuous development and improvement, Crompton Lamps Limited reserves the right to change the specification and performance data of the products listed without prior notice or public announcement.

# Fully Fire-Rated

The Firesafe has been rigorously tested to provide fire safety that you can trust, offering peace of mind and making it ideal for use both commercially and domestically.



## 30 Minute Ceiling

600mm joist centres  
Single layer 12.5mm plasterboard



## 60 Minute Ceiling

600mm joist centres  
Double layer 15.0mm plasterboard



## 90 Minute Ceiling

450mm joist centres  
Double layer 15.0mm plasterboard



# Fully IP65 Rated

## Benefits Of An IP65 Rating

- Suitable for bathroom zones 1 & 2
- Suitable for wet weather outdoor use
- Complete protection against contact dust

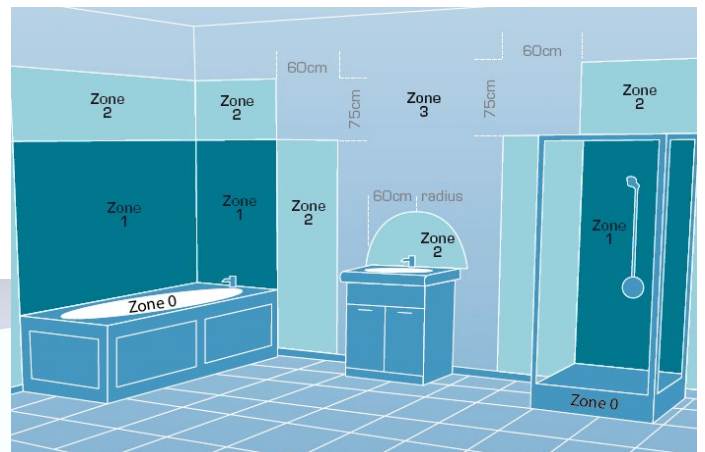

Crompton Lamps Limited  
Unit 2  
Marrtree Business Park  
Bowling Back Lane  
Bradford  
BD4 8QE

Tel: 01274 657 088  
Fax: 01274 657 087

Email: [sales@cromptonlamps.com](mailto:sales@cromptonlamps.com)  
[www.cromptonlamps.com](http://www.cromptonlamps.com)

**Trade Descriptions:** All descriptions represent only particulars of the goods to which they apply and do not form part of any contract. Due to policy of continuous development and improvement, Crompton Lamps Limited reserves the right to change the specification and performance data of the products listed without prior notice or public announcement.

# Fast, Easy and Cost Efficient Installation

The Firesafe LED Downlight is supplied with a separate loop-in/loop-out constant current driver that can be installed during the first phase of a new build or re-wiring project. Cut-down on labour costs by installing the downlight body during the final fix.

## Benefits of Loop-in/Loop-out

- Tool-less wiring connector
- Simplifies the installation process
- Reduces time required for installation



## Dimmable

Features smooth dimmable operation with DuoDim Technology ensuring compatibility with trailing and leading edge dimmers.

For a full list of compatible dimmers please visit [www.cromptonlamps.com](http://www.cromptonlamps.com)

## Excellent Cost Savings

At just 8.5W with a 50,000 hour life and 100,000 switching cycles, the Firesafe will save you money.



Annual running cost  
**£3.12**

Based on annual usage 7hrs/day @ £0.1437kWhr

Crompton Lamps Limited  
Unit 2  
Marrtree Business Park  
Bowling Back Lane  
Bradford  
BD4 8QE

Tel: 01274 657 088  
Fax: 01274 657 087

Email: [sales@cromptonlamps.com](mailto:sales@cromptonlamps.com)  
[www.cromptonlamps.com](http://www.cromptonlamps.com)

**Trade Descriptions:** All descriptions represent only particulars of the goods to which they apply and do not form part of any contract. Due to policy of continuous development and improvement, Crompton Lamps Limited reserves the right to change the specification and performance data of the products listed without prior notice or public announcement.

# Technical Information



## 8.5W All-in-one Fire-Rated Dimmable Downlight

- 30, 60 and 90 minute fire-rated
- 3000K, 4000K, 6500K tri-colour select
- Suitable for dimming
- IP65 rated
- 50,000 hour life
- 100,000 switching cycles
- 60° beam angle
- Colour rendering index  $\geq 80$
- Instant full light
- 5 year warranty

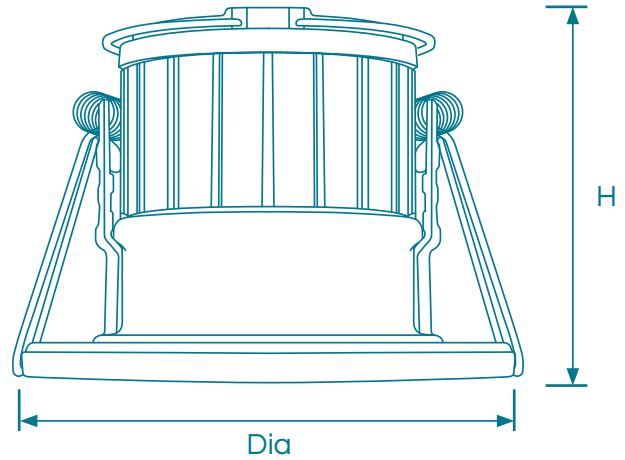

Product Code	Watts (W)	Volts (V)	Colour Appearance	Colour Temp (K)	Useful Lumens (lm)	Total Lumens (lm)	Beam Angle	Dimensions (mm)			Order Qty
								Dia	H	Cutout $\phi$	

### Single Carton

12639	8.5	240	Warm/Cool/Daylight	3000/4000/6500	650	700	60°	89	65	70-72	1
12646-10	Optional Chrome Bezel -10 Pack							89	5		1

Installation may require advice from a qualified person. Part L Compliant of UK Building Regulations. Part B Compliant BS476 Parts 21 and 22. Suitable for 30 minute 600mm/15mm single layer Standard Wallboard, 60 minute 600mm/12.5mm twin layer Fireboard and 90 minute 450mm/15mm twin layer Fireboard ceilings.

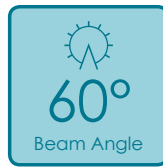
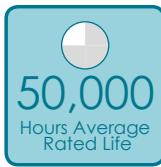

Crompton Lamps Limited  
Unit 2  
Marrtree Business Park  
Bowling Back Lane  
Bradford  
BD4 8QE

Tel: 01274 657 088  
Fax: 01274 657 087

Email: [sales@cromptonlamps.com](mailto:sales@cromptonlamps.com)  
[www.cromptonlamps.com](http://www.cromptonlamps.com)

**Trade Descriptions:** All descriptions represent only particulars of the goods to which they apply and do not form part of any contract. Due to policy of continuous development and improvement, Crompton Lamps Limited reserves the right to change the specification and performance data of the products listed without prior notice or public announcement.



ORDER

DESPATCH

RECEIVE

**NEW**



**Carriage Paid Price**

**£195**

Minimum order value of £195 for carriage paid delivery to UK mainland destinations.

Orders under £195 will be subject to a £10.00 small order charge.

Please contact our customer service team for minimum order values and delivery prices to non-UK mainland destinations.

**NEW**



**Same Day Despatch**

Order **Monday - Friday** before **4pm** for **Same Day** despatch\*.

\*We endeavour to despatch all orders received Monday - Friday before 4pm the same day.

**NEW**



**Next Day Delivery**

All UK mainland orders will be despatched by our **Next Day** delivery service\*.

\*95% of orders are delivered the next working day. For customers requiring guaranteed next working day delivery, an extra charge will be applied.

Please contact our customer service team for guaranteed next day delivery options and prices.

The above information does not include weekend delivery. Please contact our customer service team if you require a quotation for Saturday delivery.

## Visit our website and view our full range of lamps and fittings

Benefits of signing up:

- Online ordering
- Check stock and prices
- View order history
- Detailed product information
- View our comprehensive range



Crompton Lamps Limited registered in England and Wales No: 05590551

Crompton Lamps Limited  
Unit 2  
Marrtree Business Park  
Bowling Back Lane  
Bradford  
BD4 8QE

Tel: 01274 657 088  
Fax: 01274 657 087  
Email: sales@cromptonlamps.com



[www.cromptonlamps.com](http://www.cromptonlamps.com)



Design and production by Marketing,  
Crompton Lamps Limited  
E. & O. E. © Crompton Lamps Limited 2019.  
All rights reserved.