

LED MINI LINK-LIGHT



PHOEBE LED MINI LINK-LIGHTS

INSTRUCTIONS RELEVANT TO PHOEBE LED MINI-LINK LIGHT RANGE OF PRODUCTS ONLY

THANK YOU for buying this PHOEBE LED product. To help ensure this luminaire gives complete satisfaction please only use it according to the following instructions, and then pass the instructions to the appropriate person for retention and future reference.

How to Affix the Mini Link-Lights Using Mounting Brackets

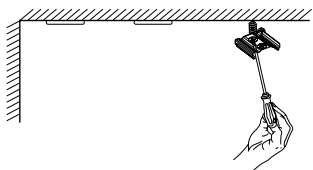

1. Affix bracket to mounting surface using the supplied screws

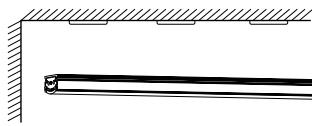

2. Place each bracket in line to hold the bar/switch as required

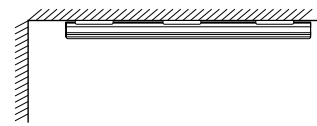

2. Align the bar/switch to the bracket and push into place



Standard Mounting Bracket

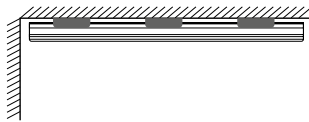

45° Mounting Bracket

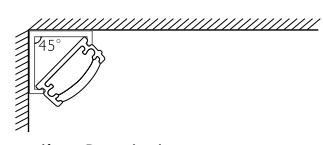

A Variety of Connectors are Available for use with the Mini-Link Light

Please Note:

Connectors need to be installed with power flowing in direction as indicated by arrow. Failure to do so may cause power interruption to next Mini Link-Light in series.

For Clear connector, please match ridge on side with ridge on Mini Link-Light for correct fitting and power flow.

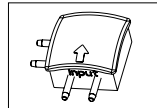

▲ 5075 2 Way Connector left

Enables user to Connect 2 Mini Link-Lights to turn Left 90°

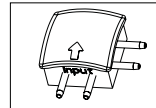

▲ 5082 2 Way Connector Right

Enables user to Connect 2 Mini Link-Lights to turn Right 90°

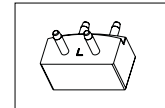

▲ 5112 L-Shaped Connector

Enables user to Connect 2 Mini Link-Lights 90° on a Vertical Axis

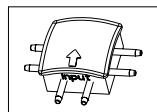

▲ 5099 3 Way Connector

Enables user to Connect 3 Mini Link-Lights in a T-Section

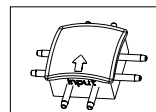

▲ 5015 4 Way Connector

Enables user to Connect 4 Mini Link-Lights in a Cross-Section

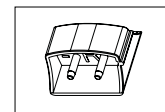

▲ Clear Connector

Enables user to Connect 2 Mini Link-Lights together (one supplied with each Mini Link-Light)

A Variety of Switching methods can be used with the Mini Link-Light

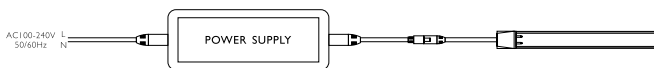

Direct

Power Supply can be connected to a wall mounted switch for operation

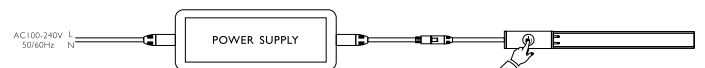

5013 On/Off Switch

Touch sensitive switch, lightly press to turn on/off (one supplied with each power supply, additional switches may be purchased)

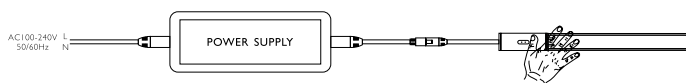

5037 Motion Sensor

Sweep hand across sensor to turn on/off Sensor effective range upto 6" (15cm)

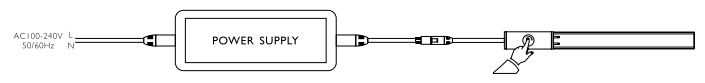

5020 Dimmer Switch

Tap to turn on, keeping finger on dimmer to switch smoothly between 0-100%. Release at desired level. Tap to turn on, tap again to switch in 25% increments from 25%-50%-75%-100% Double Tap to Switch Off

Images are for information only. Phoebe LED shall not be held liable for improper operation of the luminaire in circumstances where procedures and specifications have not been followed correctly. Phoebe Mini Link-Light Products must be installed by a qualified Electrician. IP20 Rated not suitable for outdoor use.

Tel: +44 (0) 1274 657 088 Fax: +44 (0) 1274 657 087 Web: www.phoebeled.com

Mini Link-Lights can be configured for the users needs

See example below

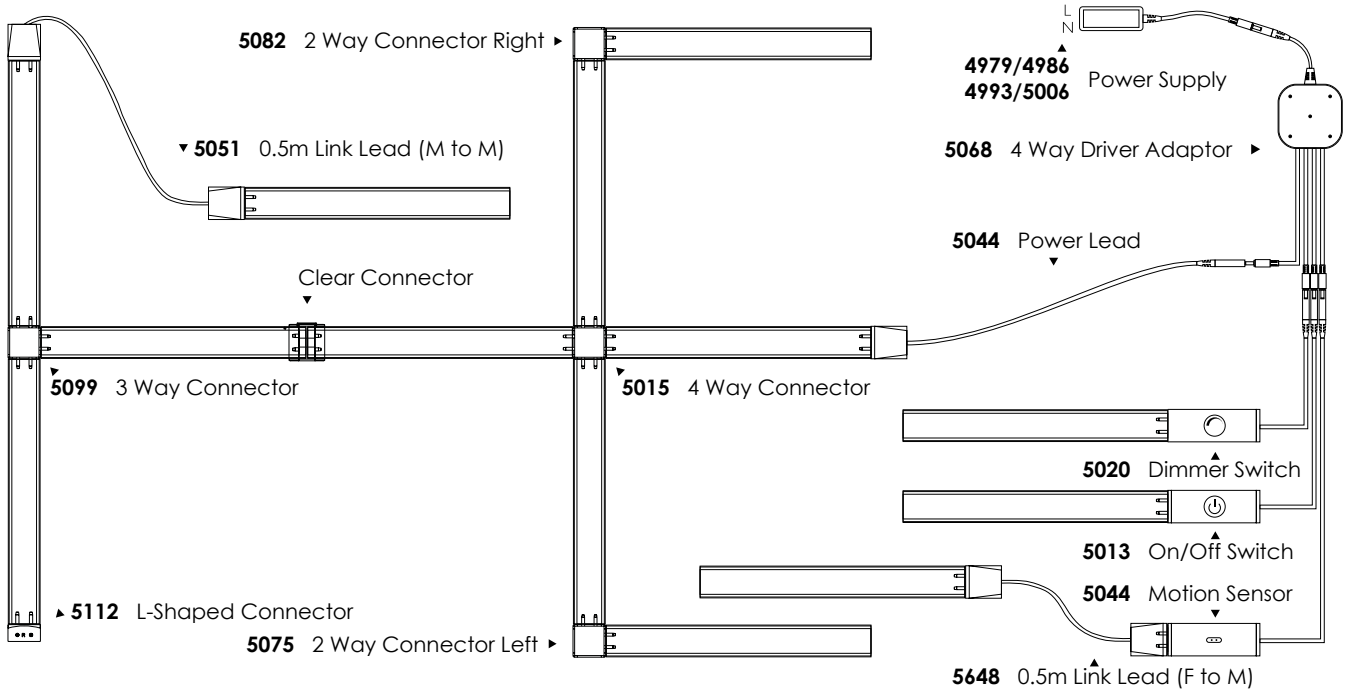

Configuration Guide

Mini Link-Light Parts Lists

BE YOUR OWN LIGHTING DESIGNER

CHOOSE YOUR COLOUR & LENGTHS

Warm White Mini Link-Light	15cm 2.5W Mini Link-Light 4894	30cm 5W Mini Link-Light 4900
	60cm 9W Mini Link-Light 4917	100cm 15W Mini Link-Light 4924
Cool White Mini Link-Light	15cm 2.5W Mini Link-Light 4931	30cm 5W Mini Link-Light 4948
	60cm 9W Mini Link-Light 4955	100cm 15W Mini Link-Light 4962

CHOOSE YOUR POWER SUPPLY

Power Supply	18W Power Supply 4979 Powers up to 1.2m	36W Power Supply 4986 Powers up to 2.4m	60W Power Supply 4993 Powers up to 4m	120W Power Supply 5006 Powers up to 8m
--------------	------------------------------------------------------	------------------------------------------------------	----------------------------------------------------	-----------------------------------------------------

CHOOSE YOUR SWITCH

Switches	Touch Sensitive On/Off 5013	Touch Sensitive Dimmer 5020	Motion Sensor On/Off 5037
----------	--------------------------------	--------------------------------	------------------------------

CHOOSE YOUR CONNECTORS & ACCESSORIES

Mounting Brackets	Spare Brackets x4 5129	45° Brackets x4 5136	Connecting Blocks			
			2-Way Left 5075	2-Way Right 5082	3-Way T-Shaped 5099	4-Way 5015
		Link Leads				
		50cm Link Lead (male to male) 5051		50cm Power Lead 5044		
		50cm Link Lead (female to male) 5648		4-Way Power Lead 5068		

Images are for information only. Phoebe LED shall not be held liable for improper operation of the luminaire in circumstances where procedures and specifications have not been followed correctly. Phoebe Mini Link-Light Products must be installed by a qualified Electrician. IP20 Rated not suitable for outdoor use.

Tel: +44 (0) 1274 657 088 Fax: +44 (0) 1274 657 087 Web: www.phoebeled.com